



OPERATOR'S MANUAL

ACCU-CUT j-5

Carpet and Vinyl Cut & Roll Machine

**For Parts or Service contact
Accu-Cut Support 1-800-222-8288**

Brockie International Inc. 28114 County Road 561, Tavares, Florida 32778
voice 800.222.8288 ♦ 352.742.0902 fax 352.742.0702
e-mail: info@accu-cut.com ♦ www.accu-cut.com

CONTENTS

INTRODUCTION	3
SAFETY PRECAUTIONS	4
ABOUT THE MACHINE	5
OPERATING PROCEDURES.....	6
•Procedures for cutting	
Loading the material-----	6
Unwrapping new & tightening loose rolls-----	6
Positioning the material-----	6
Entering the cut length-----	7
Setting the speed control-----	7
Rolling up the material-----	8
Monitoring the roll-----	8
Cutting the material-----	9
Wrapping the cut length-----	9
Dumping the cut length-----	10
•Measuring roll balances	
How to-----	10
•Procedures for reverse rolling	
Rolling up the material-----	11
A few words about reverse rolling-----	11
PREVENTIVE MAINTENANCE.....	12
TEST STRIP INSTRUCTIONS.....	13
ELECTRICAL DIAGRAM.....	14

INTRODUCTION

Congratulations on the purchase of your Accu-Cut J-5 carpet and vinyl cutting and rolling machine. Your Accu-Cut machine has been carefully engineered and manufactured to provide you with many years of dependable service and trouble free operation.

Proper operation and maintenance is essential to ensure precise and dependable operation of your Accu-Cut. We encourage you and your employees to read this manual carefully and become familiar with the operating and maintenance procedures for this machine.

This manual is designed to cover all areas of operation, maintenance, and troubleshooting in order to minimize problems. Always follow safety rules and precautions when operating or performing maintenance work on the machine.

Again, congratulations and thank you for choosing Brockie International to provide you with quality equipment and quality service. The confidence you and thousands of others have placed in us has helped to make Accu-Cut the most respected name in floor covering cutting equipment. Should you ever have any questions or concerns regarding your Accu-Cut please do not hesitate to contact us.

BROCKIE INTERNATIONAL, INC.

SAFETY PRECAUTIONS

In order to avoid personal injury, make sure the operator(s) and/or maintenance person(s) of the machine have been oriented with the machine's operating procedures and are aware of all safety precautions.

- 1. Unplug power cord before making any adjustments or repairs.**
- 2. A qualified electrician should perform electrical repairs.**
- 3. Do not operate machine on a wet floor.**
- 4. Use extreme caution when replacing cutter blades.**
- 5. Keep hands clear of all moving components while machine is running.**
- 6. Keep loose clothing and articles away from all moving components while machine is running.**
- 7. Keep machine unplugged while not in use.**
- 8. Do not allow children near the machine.**
- 9. Keep machine clean of all plastic wrap, carpet fibers, and all other debris.**
- 11. Ensure machine is stationary and will not roll on casters.**
- 12. Do not remove chain covers except for servicing.**
- 13. Keep space beside cradles (dumping areas) clear.**

ABOUT THE MACHINE

The Accu-Cut J-5 cut and roll machine consists of two sets of steel rollers that are referred to as cradles. The side where material is loaded is the **load side cradle**, while the opposite side is the **roll up cradle**. The roll up cradle is designed to run slightly faster than the load side to ensure a tight roll up of material. Each cradle is chain driven by heavy duty UL & CSA approved electric motors.

The J-5 is operated from the **control panel**, which includes the **directional controls**, **variable speed control**, **cutter controls**, and the **electronic, auto-stop counter**.

The Accu-Cut J-5 measuring system is extremely accurate. It consists of a large diameter, knurled **measuring wheel** located in a cutout of the **inspection table** below the **hold down arm**. The measuring wheel is connected to an advanced encoder which communicates with the electronic, auto-stop counter to provide you with an accurate measurement.

The cutter assembly on the J-5 consists of two, standard, slotted blades positioned within a cutter assembly inside the **cutting track**. The cutter assembly is chain driven by a dedicated cutter motor. The rubber o-rings on the wheels of the cutter assembly are removable and are mainly beneficial when cutting vinyl - they are not required when cutting carpet.

A wrap around **foot control cable** is provided to operate the machine "hands free" while inspecting wrapping, unwrapping, or tending the roll.

The J-5 also includes a **dumping mechanism** on the **roll up cradle** that will quickly and simply offload the cut material onto the floor allowing another cut to be made without using a forklift to unload the cut piece.

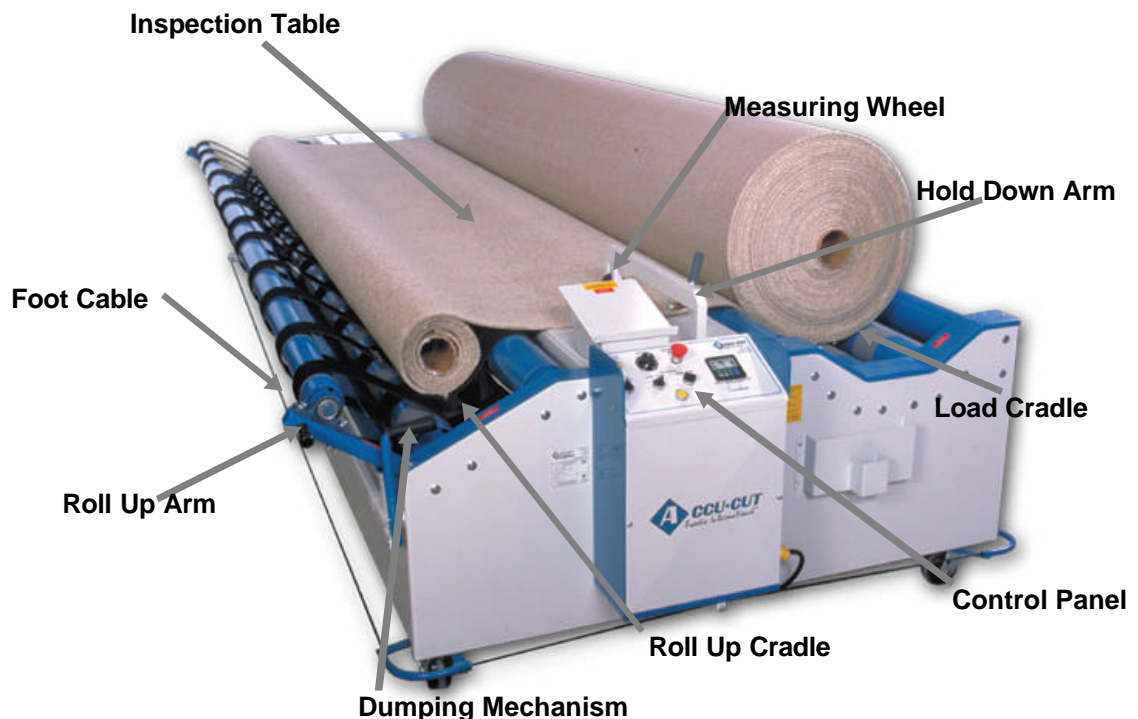

OPERATING PROCEDURES

Keypad Familiarization

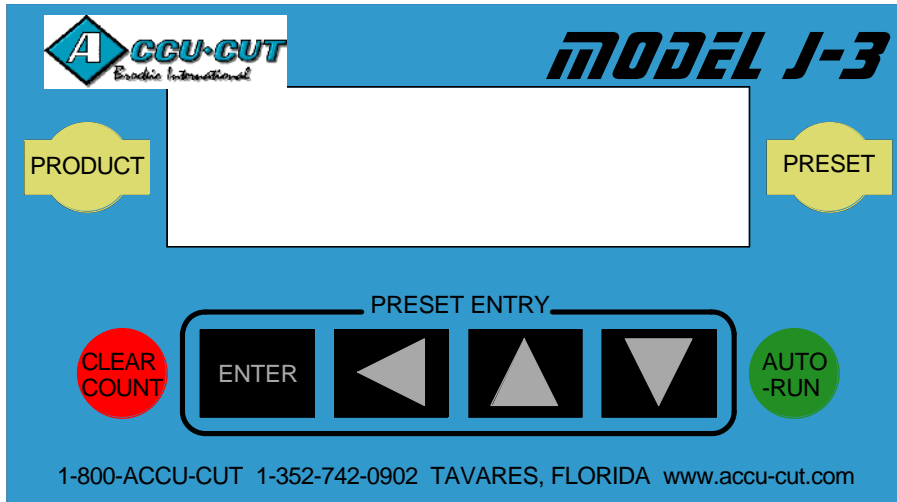

Black keys----- *Data entry*—used for entering numeric data

Yellow keys --- *Product*—scrolls through the product settings—used if materials are measuring differently—factory default for all product settings is the same
Pre-set—scrolls through the 5 different cut storage settings and the no-stop setting

Red key----- *Clear count* button clears the counter value to 0' 0"





Green key----- *Auto-Run* button places machine in auto-run mode—indicated by a v in the bottom right of the display. In auto-run mode the machine will operate until the programmed length is reached or until the auto-run feature is deactivated. Pressing the foot cable control or the auto-run button will stop the auto-run feature.

Password Protection

The j-5 is equipped with a "Password Protection" feature. Each time the machine is turned on the machine prompts the user to enter a password. The factory preset is "4321".

```
-----  
| ENTER  
| PASSWORD XXXX |  
-----
```

To enter the password:

1. Press  (a cursor appears below the number to the right)
2. Press   (this increases or decreases the number)
3. Press  (this moves to the next digit)
4. Repeat process for remaining digits
5. Press  when the 4 digit number is entered

PROCEDURES FOR UNROLLING AND CUTTING

Loading the material

Place the material on the **load side cradle**, making sure the leading edge of the material is feeding across the **inspection table** from the **bottom of the roll** with the **pile side up and the backing down** – vinyl can be measured pattern up or down. Make sure the roll is positioned so that the edge of the material is between the **measuring wheel** and the **cutter assembly** (see photo 1A).

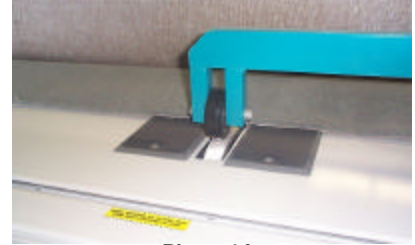

Photo 1A

Unwrapping new rolls and tightening loose rolls

After loading the wrapped roll, cut the plastic the full length of the roll and at each end. Position the load cradle **roller directional switch** in the reverse position, and then step on the **foot cable control** while pulling off the plastic wrapping.

If you have a loose roll, run the **load cradle** rollers in reverse by placing the load cradle **roller directional switch** in the reverse position and pressing the **jog button** or stepping on the **foot cable control** to activate the load cradle rollers. Continue to run the rollers in reverse until the roll has tightened.

Positioning the material

Raise the **hold down arm**, lifting it off the **measuring wheel**. Set both **roller directional switches** to forward. Step on the **foot cable control** or press the **jog button**, advancing the material to the center of the **cutting track** (see photo 3A). Now lower the **hold down arm** back on to the **measuring wheel**. Failure to lower the **hold down arm** will result in an inaccurate measurement.

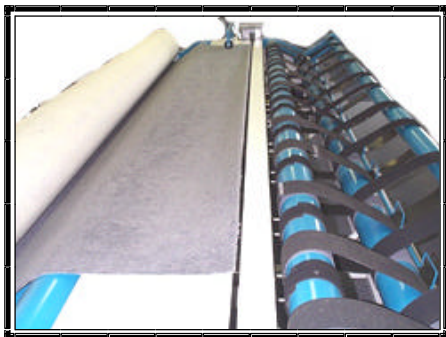

Photo 3A







Photo 3B

Note: If the material is off square, line the trailing edge of the material with the **cutting track** (see photo 3B).

Entering the cut length

With the material lined up in the center of the cutting track the desired cut length can now be programmed.

```
-----  
| B           |  
| CARPET #1  XXXX |  
|           |  
-----
```

- To enter a preset length:
1. Press  (a cursor appears below the number to the right)
 2. Press   (this increases or decreases the number)
 3. Press  (this moves to the next digit)
 4. Repeat process for remaining digits
 5. Press  when the desired length is entered

Clearing the counter - resetting to zero

Once the desired length is programmed the counter must be reset to zero. To do this simply press the red



button

The roll up process can now be started.

Setting the speed control

The speed at which the rollers turn can be quickly and simply adjusted by turning the **variable speed control knob** located on the control panel. Keeping the speed at a low setting when beginning the roll up process and increasing the speed as the roll increases in size is recommended.



Photo 5

Rolling up the material

After setting the **counter**, either press the **hand control button** or step on the **foot cable control**, while pulling the material across the inspection table and under the hold down arm by hand. Advance the leading edge of the material until it is half way between the last two rollers on the **roll-up cradle** (see *photo 8A*). Pulling up the **roll-up arm** will fold over the material and start the roll-up procedure. If using a tube, place the tube on top of the material, then pull up the **roll-up arm** folding the material over the tube (see *photo 8B*).



Photo 8A



Photo 8B

Continue to apply pressure with the **roll-up arm** until the material has made six or seven revolutions (see *photo 8C*). At this time the **roll-up arm** can be lowered to its original position (see *photo 8D*). Now the machine can be operated while stepping on the **foot cable control** allowing the roll to easily be monitored and adjusted if necessary.



Photo 8C



Photo 8D

Monitoring the roll

Make sure the roll-up is started tight and square. If the roll begins to “walk” one way or the other, move to that end of the roll and push the roll in towards the **inspection table** as it rolls. This will cause the side walking to catch up with the other side straightening the roll and reducing any “coning” of the roll. Do not be concerned if the roll appears somewhat loose. After the cut has been made, or the end of the roll is reached, continuing to rotate the roll in the **roll-up cradle** will cause the material to tighten.

Cutting the material

When the counter approaches the programmed measurement the machine will automatically slow down and stop precisely at the programmed length. Before activating the cutter ensure the material is tight across the **cutting track**. If the material is not tight, positioning the roll-up cradle **roller directional switch** in forward and the load cradle **roller directional switch** in reverse and briefly pressing the **hand control button** will tighten the material across the **inspection table**.

Once the material is tight across the **cutting track**, engage the cutter by turning and holding the **cutter directional switch** to the direction desired then press and hold down the **cutter safety button**. Releasing the button or switch will stop the cutter. When the cutter has reached the end of the **cutting track** it will automatically come to a stop. The cutter cuts in both directions allowing it to be left at either end of the machine after a cut has been made.

Note: When processing 15' wide material the cutter must be stored at the **control panel** end of the machine. If the cutter is left at the far end of the machine it will interfere with the material as it moves across the **inspection table**.

Wrapping the cut length

To wrap the cut length, keep the roll-up cradle **roller directional switch** in the forward position and place the load cradle **roller directional switch** in the off position. Place the wrapping material inside the flap of the material you are wrapping. Stepping on the **foot cable control** will rotate the roll, letting you wrap the material while it is still on the machine.



Photo 11A



Photo 11B

Caution: Keep hands and all loose clothing away from moving parts.

Dumping the cut length

The cut length can be dumped on to the floor by pulling the **dumping mechanism** that lowers the **roll-up arm** into the dump position. When the **roll-up arm** is in the dump position the cut length will fall to the floor. For smaller cut lengths it may be necessary to engage the roll-up side cradle to dislodge the material from the cradle to the floor or simply push the material to the floor by hand.



Photo 12A



Photo 12B



Photo 12C

Dumping
mechanism

Caution: Make sure the area is clear before dumping the cut length.

MEASURING ROLL BALANCES

To determine the balance remaining on a roll or to check the length of a new roll perform the following procedures:



- ◆ Scroll through the preset measurements using the  key until “no stop” is reached. This allows the machine to run without stopping when a programmed length is reached.
- ◆ Line up the edge of the material to be measured to the center of the **measuring wheel** pile side up. (see photo 13).
- ◆ Press  to reset the counter to zero.
- ◆ Follow the procedures for “Rolling up the material” detailed on page 9.
- ◆ Continue rolling up the material until the final few feet of the roll is reached. At this point put the machine in the low speed setting and continue advancing the material until it is centered with the **measuring wheel**.
- ◆ The measurement indicated on the counter is the length of the material.



Photo 13

Note: Failure to slow down the rollers at the end of the measurement may result in the measuring wheel continuing to turn *and* measure even after the trailing edge of the material has passed the wheel. This will result in an inaccurate measurement.

PROCEDURES FOR REVERSE ROLLING

Reverse rolling is an effective manner of merchandising remnants. Several dealers even merchandise full rolls pile side out. An optional **top counter** and **pinch roller** may be necessary for reverse rolling full rolls. Contact your Accu-Cut representative for details on these options.

The procedures for reverse rolling are identical to the procedures for “*Measuring roll balances*” (page 10) with the following exceptions:

Rolling up the material

After setting the **counter**, either press the **hand control button** or step on the **foot cable control**, while pulling the material across the inspection table and under the hold down arm by hand. Advance the leading edge of the material until it is half way between the last two rollers on the **roll-up cradle** (see photo 14A). Position the material on top of the tube. Use of a tube is strongly recommended.

Leave the load cradle **roller directional switch** in the forward position but place the **roll-up cradle roller directional switch** in the reverse position.

Pull up the **roll-up arm** and engage the rollers by stepping on the **foot cable control** or pressing the **jog button**. The **roll-up arm** will cause the material to begin rolling in reverse around the cardboard tube and start the roll-up procedure. (see photo 14B). After the material has made several revolutions lower the roll-up arm. (see photo 14C).

NOTE: If the material is walking up on the inspection table momentarily shut off the roll-up cradle to allow load cradle to catch up.



Photo 14A



Photo 14B



Photo 14C

A few words about reverse rolling

Reverse rolling is a simple process but often takes time to perfect and learn – be patient. There are numerous times when and how reverse rolling can occur. We have tried to list the most common below.

Reverse rolling the balance of a roll after making a cut:

After removing the cut length from the roll-up cradle, reverse the material in the load cradle so that the leading edge is centered with the measuring wheel. Reset the counter to zero then follow the steps at the top of the page. The measurement indicated on the counter is the length of the material.

Reverse rolling with the material coming off the top of the roll and pile side down:

If the length of a roll is already known, some operators will choose to reverse roll the material having the material feed from the top of the roll with pile side down. This method allows the operator to keep roll-up cradles in the forward position, load side reverse and use the roll-up arm in the same manner as when making a cut. *Please note that it is not possible to get an accurate measurement with the pile side down.*

PLC / INTERFACE FEATURES

Multiple pre-programmed lengths

The j-5 is equipped with up to five pre-programmed lengths. Pressing the  button will scroll through each setting. To program a measurement follow the steps detailed on page 8. A programmed measurement is stored in memory—even when the machine is unplugged. This feature is useful for commonly made cut sizes.

The j-5 also features a “no stop” setting. When the counter is set to the “no stop” setting the machine will not stop when a certain measurement is reached. This setting is useful when measuring a roll balance.

Multiple product settings



Sometimes different products grip the measuring wheel differently due to their adhesive nature—while the difference between products is typically minimal we have taken this into consideration and provided a method to accurately measure three different types of products. Different product settings may be selected by pressing the  button.

Each product setting is set to the same “scale factor” (will provide the same measurement) as a factory default. If you have product that is measuring inaccurately contact Accu-Cut Service at 1-800-222-8288 for details on modifying the scale factor in one of the product settings.

Auto-Run Feature

The j-5 is capable of running automatically without pressing the “jog” button or pressing on the foot cable control. In auto-run mode the machine will operate until the programmed length is reached or until the auto-run feature is deactivated. Pressing the foot cable control or the auto-run button will stop the auto-run feature. A checkmark v appears in the bottom right of the display when the auto-run feature is activated.

To use the auto-run feature to automatically stop at a programmed length:



1. Follow the procedures for setting the preset length.
2. Bring material to the center of the cutting bar
3. Verify that the desired cut length in is in the display.
4. Press  button to clear the counter.
5. Begin the roll-up process.
6. Once you have a few feet of material in the roll-up cradle you can press the  button.

The machine will run until the programmed length is reached.





To use the auto-run feature for wrapping or taping material:

1. Set the roller directional switches in the desired direction.
2. Press the green Auto-Run button.
3. Press the foot cable control to start the machine. Press the foot cable control again to stop the machine.



Master User's Menu

Some functions on the j-5 can be customized to best suit the machine operator. To access the MASTER PASSWORD simultaneously press  and  then immediately press 

```
-----  
| ENTER MASTER |  
| PASSWORD XXXX |  
-----
```

- To enter master password:
1. Press  (a cursor appears below the number to the right)
 2. Press   (this increases or decreases the number)
 3. Press  (this moves to the next digit)
 4. Repeat process for remaining digits
 5. Press  when the 4 digit number is entered





The master password is 2442

Once access to the Master User's Menu has been obtained you can use the  button to scroll left and the  button to scroll right to access the various features.

Imperial or Metric Measurements

The j-3 can measure in either imperial (feet and inches) or metric.





```
-----  
| 0=IMPERIAL    0 |  
| 1=METRIC      X |  
-----
```

- To change the setting:
1. Press  (a cursor appears below the number to the right)
 2. Press   (set to 0 for imperial or 1 for metric)
 3. Press  when the desired setting is displayed.

Changing the Password

The four digit security code is changeable for your convenience.

```
-----  
| ENTER NEW           0 |  
| USER PASSWORD  XXXX |  
-----
```

- To enter a new password:
1. Press  (a cursor appears below the number to the right)
 2. Press   (this increases or decreases the number)
 3. Press  (this moves to the next digit)
 4. Repeat process for remaining digits
 5. Press  when the 4 digit number is entered

Eliminating the Password

Follow the steps above for changing the password but set the password to 0-0-0-0. The machine will no longer prompt for a password at power up.

Calibration Settings

Each of the product settings can be adjusted to accurately measure the product. If you have a product that is measuring inaccurately make a test strip of the product (see page 17) and contact Accu-Cut Service at 1-800-222-8288 for details on modifying the scale factor in the product setting.

To exit the Master Menu press the emergency stop button.

PREVENTIVE MAINTENANCE

Weekly:

1. **Check conditions of belts and belt lacing.** Repair, if possible, any damaged belt lacing contact Accu-Cut for replacement belts.
2. **Check control switches** for proper operation.
3. **Check operation of counter assembly.**
 - ◆ Check that measuring wheel is secure and does not have any cracks or excessive wobble.
 - ◆ Check the “grooves” or “knurls” on the measuring wheel. Ensure the wheel does not have smooth or bald spots.
 - ◆ Make sure wheel is at proper height above opening in the table. Wheel must be at least a credit card thickness above opening or the pads on either side of the opening.
 - ◆ Check condition of measuring wheel shaft and its connection to the counting device. Make sure the shaft is secure and not bent.
4. **Clean machine** of debris and/or carpet fibers, particularly on or around the motor areas, chains, sprockets and cutting track.
5. **Check tension on all cables and chains.** Adjust as necessary for proper operation.
6. **Check calibration of counter.** Follow the Test Strip Instruction sheet in this manual to check your calibration. Contact your Accu-cut Service Representative before attempting re-calibration.

Monthly:

1. **Check the alignment** of all sprockets, pulleys and rollers for proper operation.
2. **Check allen screws** on all sprockets, pulleys and locking collars.
3. **Check condition of the electrical outlet** on machine. Ensure outlet is secure.
4. **Check gearboxes** for proper oil level. Use 90-weight gear oil, if needed.
5. **Lubricate all drive chains** with light oil.

Yearly:

1. **Lubricate all roller bearings** with grease gun
2. **Lubricate all bearings for cutter drive assembly** with grease gun.
3. **Lubricate counter shaft bearings** with grease gun.
4. **Lubricate swivel castor wheels** with grease gun.

TEST STRIP INSTRUCTIONS

How to make a test strip:

1. Cut a strip of carpet that is 4 " wide by 13' long.
2. Center your tape measure on strip of carpet.
3. Draw a line at 0 and a line at 12'.
4. DO NOT cut off excess material.

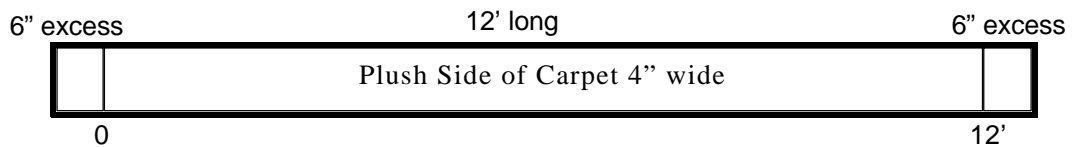

How to use a test strip:

1. Unwind test strip plush side up, line up the black hold down arm over wheel with 1st black line on test strip.
2. Reset counter to zero.
3. Slowly pull test strip across the measuring wheel.
4. Stop at 2nd black line, counter should read 12 feet.
5. Repeat the test 3 or 4 times.
6. If measurement is off contact your Accu-Cut Service Representative.

ELECTRICAL DIAGRAM

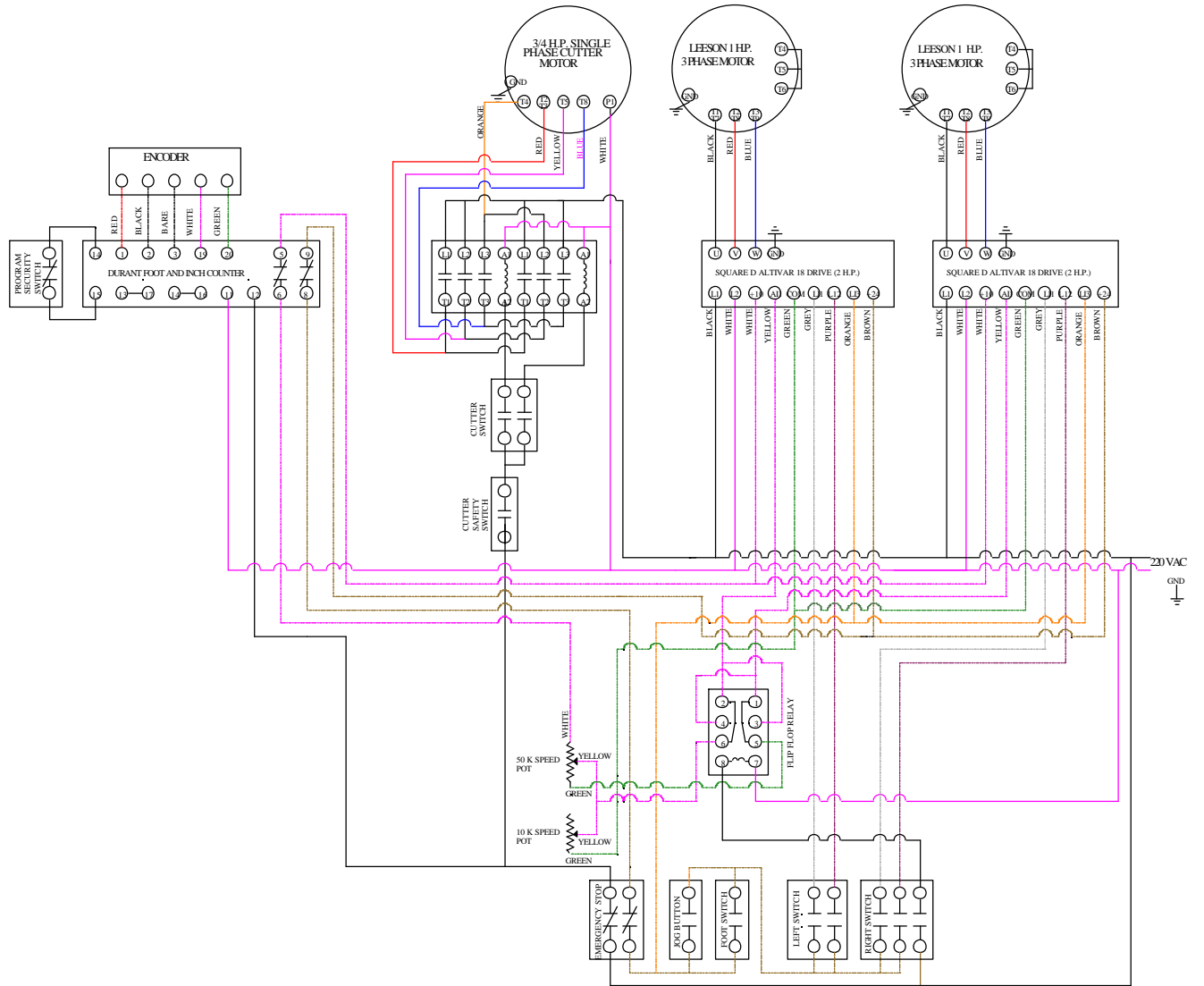

'j-5' model

Certificate of Warranty

STATEMENT OF LIMITED WARRANTY

BROCKIE INTERNATIONAL, INC. ("BROCKIE") warrants to the original purchaser ("Purchaser") of this ACCU-CUT machine that should it prove defective by reason of improper workmanship and/or material:

- a. **Labor.** For one year from the date of delivery, BROCKIE will provide labor for a warranty repair without charge to Purchaser.
- b. **Parts.**
 - i. DURING THE FIRST YEAR FROM THE DATE OF DELIVERY, BROCKIE will repair or replace, at its option, any defective part without charge to Purchaser for the part. Parts used for replacement will be warranted for the remainder of the original warranty period.
 - ii. DURING THE SECOND YEAR FROM THE DATE OF DELIVERY, BROCKIE will repair or replace, at its option any defective part paying for 66% of the cost of the part. The Purchaser shall be responsible for 34% of the cost of the part.
 - iii. DURING THE THIRD YEAR FROM THE DATE OF DELIVERY, BROCKIE will repair or replace, at its option any defective part paying for 33% of the cost of the part. The Purchaser shall be responsible for 67% of the cost of the part.

1. TO OBTAIN WARRANTY SERVICE, contact Brockie International, Inc. at the address and phone number below. BROCKIE will only pay for warranty service performed by a Brockie International, Inc. authorized technician authorized by BROCKIE to perform warranty service on your machine.

2. Buyer shall have the right to inspect the machine(s) before acceptance or payment. THERE SHALL BE NO IMPLIED WARRANTY WITH REGARD TO DEFECTS WHICH AN EXAMINATION PRIOR TO ACCEPTANCE OUGHT TO REVEAL. Buyer shall accept or reject any machine with three (3) days of receipt by Buyer.

3. THE LIMITED WARRANTY SHALL NOT APPLY TO any defects resulting from, but not limited to: abuse, lack of maintenance, unapproved modifications, overloading, power surges, inadequate power supply including extension cords, misuse, fire, flood or acts of God such as lightning. This limited warranty does not include normal wear and tear of parts or equipment including, but not limited to, belts, blades, blade holder assemblies, and grip tape. BROCKIE reserves the right to repair or replace, at its sole option, any defective part and/or any components, within the warranty period. THERE ARE NO WARRANTIES WHICH EXTEND BEYOND THE DESCRIPTION ON THE FACE HEREOF.

4. BROCKIE WILL SHIP REPLACEMENT PARTS via normal ground freight, pre-paid to the Purchaser during the warranty period. *It is the responsibility of the purchaser to return all defective parts, freight pre-paid, to BROCKIE within 30 days for warranty consideration.* Any extra freight costs for special shipping, such as airfreight or overnight shipping, is the responsibility of the Purchaser.

5. BROCKIE INTERNATIONAL, INC.'S LIABILITY AND PURCHASER'S REMEDIES UNDER THIS WARRANTY SHALL BE SOLELY LIMITED TO THE REPAIR AND/OR REPLACEMENT OF DEFECTIVE PARTS AND SHALL NOT BE LIABLE UNDER ANY CIRCUMSTANCES, FOR CONSEQUENTIAL OR INCIDENTAL DAMAGES, LOST INCOME DUE TO DOWNTIME, PERSONAL INJURIES, DAMAGE TO PERSONAL PROPERTY OR LABOR COSTS.

6. ANY EXPRESS OR IMPLIED WARRANTY NOT PROVIDED HEREIN, AND ANY REMEDY WHICH, BUT FOR THIS PROVISION, MIGHT ARISE BY IMPLICATION OR OPERATION OF LAW, IS HEREBY EXCLUDED AND DISCLAIMED.



Brockie International, Inc.
28114 CR 561
Tavares, Florida 32778
352-742-0902 / 800-222-8288